











Assembly Instruction

Part List

| NO. | Picture | Name | Qty |
|-----|---|-----------------|-----|
| A |  | Table Rim | 1 |
| B |  | Table leg | 4 |
| C |  | Fixing Ring | 1 |
| D |  | Bolt cover | 8 |
| E |  | Bolt M6x25 | 8 |
| F |  | Washer | 12 |
| G |  | Wrench For Bolt | 1 |
| H |  | M6 Nut | 4 |
| I |  | Nut Cover | 4 |
| J |  | Wrench For Nut | 1 |

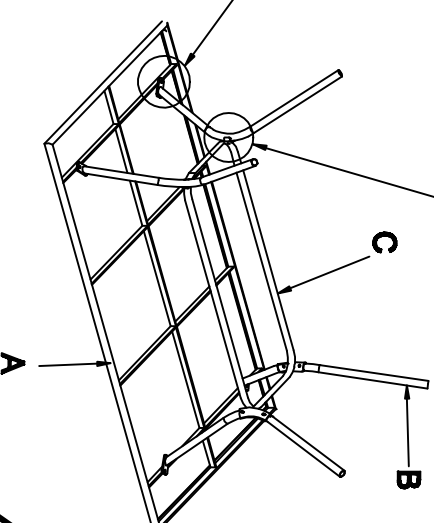
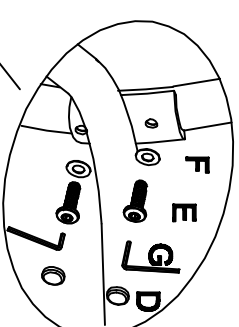
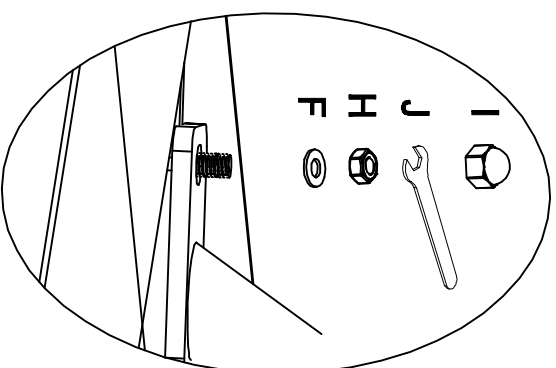
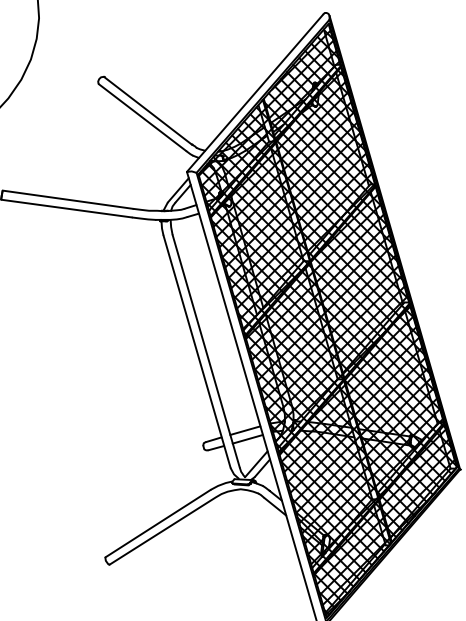

41774