

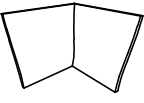











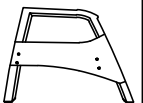
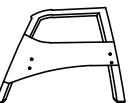

Assembly Instructions

IMPORTANT,RETAIN FOR FUTURE REFERENCE:READ CAREFULLY

Pls tighten all the screws a little bit firstly. After all the screws are put in the hole, you can tighten all the screws.
Do not tighten the screws one by one.

Caution: Assemble only with assistance from adults.Do not assemble in presence of children and or being assisted by a child.

A	B	C	D	E	F	G	H	I
								
1PC	1PC	3PCS (Φ16x8.5x1.5)	3PCS (m8x30)	1PC (6mm)	1PC	1PC	1PC	1PC
J	K	L	M	N	O	P	Q	
								
12PCS (Φ14x6.5x1)	12PCS (1/4x35)	1PC (4mm)	2PCS	1PC	1PC (Corner sofa cushion)	5PCS	5PCS	

1

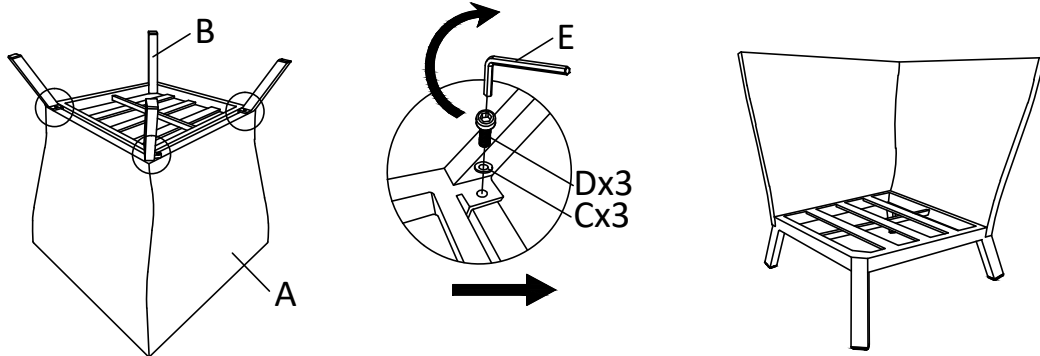

Option A

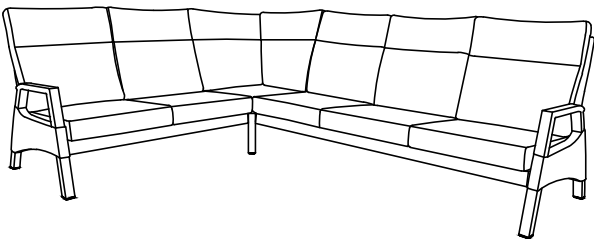

Option B

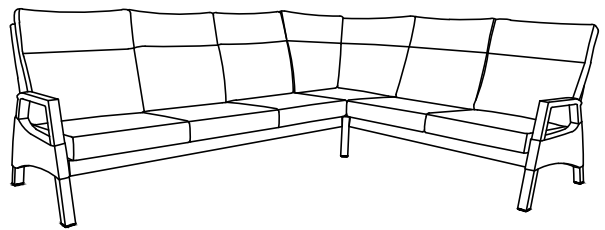

2

