









# Assembly Instruction

## Part List

NO.	Picture	Name	Qty
A		Frame	1
B		Connect Tube	1
C		Washer	6
D		Bolt M6x20	6
E		Bolt Cover	6
F		Wrench	1
G		Back Cushion	1
H		Seat Cushion	1

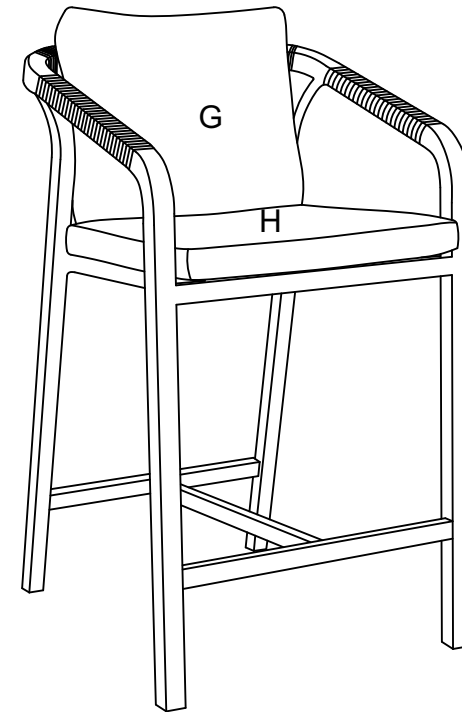
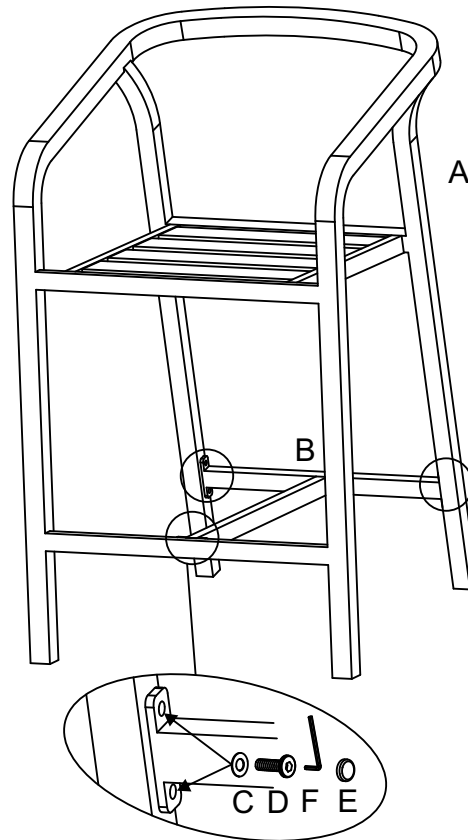

(41667)