

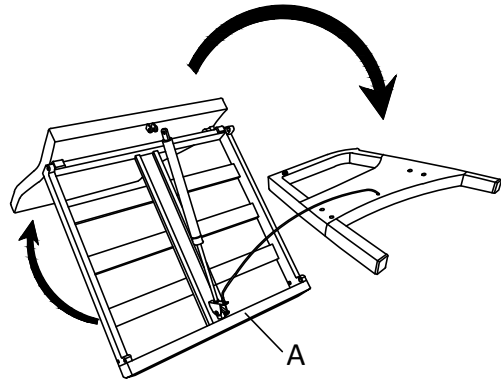

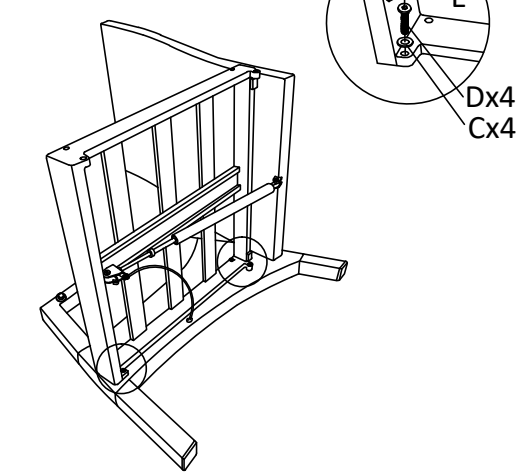

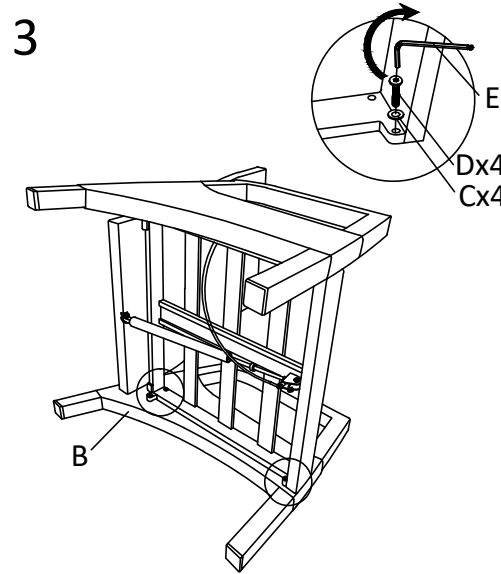
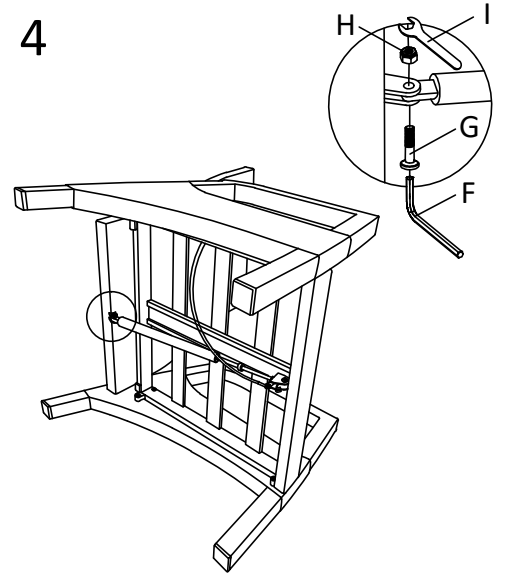
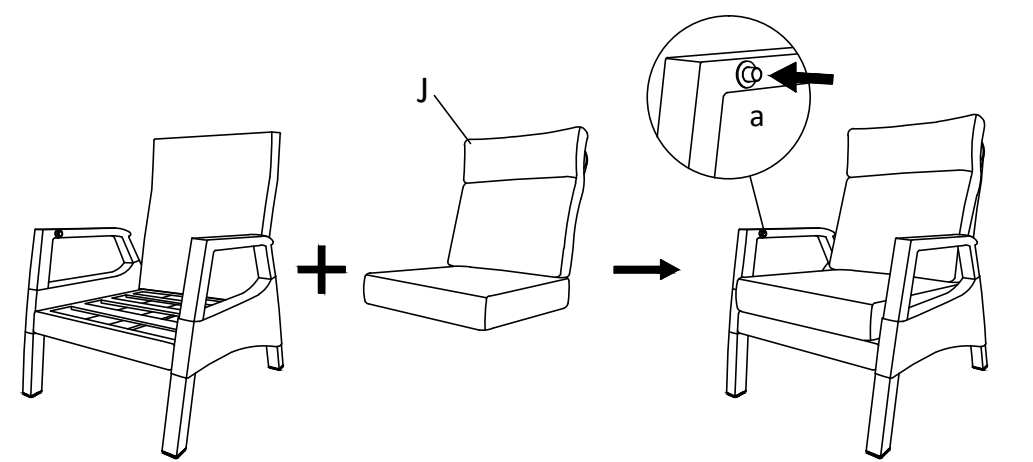
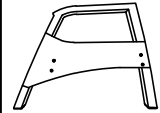
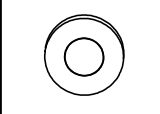

Assembly Instructions

No.	Drawings	Q'TY	IMPORTANT,RETAIN FOR FUTURE REFERENCE:READ CAREFULLY	
A		1PC	<p>Pls tighten all the screws a little bit firstly. After all the screws are put in the hole, you can tighten all the screws. Do not tighten the screws one by one.</p> <p>Caution: Assemble only with assistance from adults.Do not assemble in presence of children and or being assisted by a child.</p> <div style="display: flex; justify-content: space-around;"> <div style="width: 45%;"> <p>1</p>  </div> <div style="width: 45%;"> <p>2</p>  </div> </div> <div style="display: flex; justify-content: space-around;"> <div style="width: 45%;"> <p>3</p>  </div> <div style="width: 45%;"> <p>4</p>  </div> </div> <p>5 <u>Press this button(a) to adjust the back</u></p> 	
B		1PC		
C	 (Φ14x6.5x1)	8PCS		
D	 (1/4x35)	8PCS		
E	 (4mm)	1PC		
F	 (5mm)	1PC		
G	 (M8x15xΦ8x15)	1PC		
H		1PC		
I		1PC		
J		1PC		

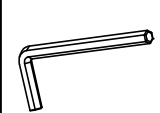
What to do if the gas spring for adjusting the backrest does not work or does not work properly.
Wat te doen als de gasveer voor het verstellen van de rugleuning niet of niet goed functioneert.
Was ist zu tun, wenn die Gasfeder zum Verstellen der Rückenlehne nicht oder nicht richtig funktioniert.

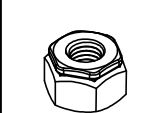

Situation A
Situatie A
Situation A

Backrest automatically returns to the starting position
Rugleuning gaat automatisch weer naar de begin positie
Rückenlehne kehrt automatisch in die Ausgangsposition zurück

Step 1: Loosen the nut (b) 1-2 mm.
Step 2: Slide the gas spring cable up 1-2mm in the direction indicated by the arrow below.
Step 3: Tighten the nut (a).

Stap 1: Draai de moer (b) 1-2 mm los.
Stap 2: Schuif de kabel van de gasveer 1-2mm op in de richting die de pijl hieronder aangeeft.
Stap 3: Draai de moer (a) aan.

Schritt 1: Lösen Sie die Mutter (b) um 1-2 mm.
Schritt 2: Schieben Sie das Bowdenzug 1-2 mm in die durch den Pfeil unten angegebene Richtung.
Schritt 3: Ziehen Sie die Mutter (a) an.

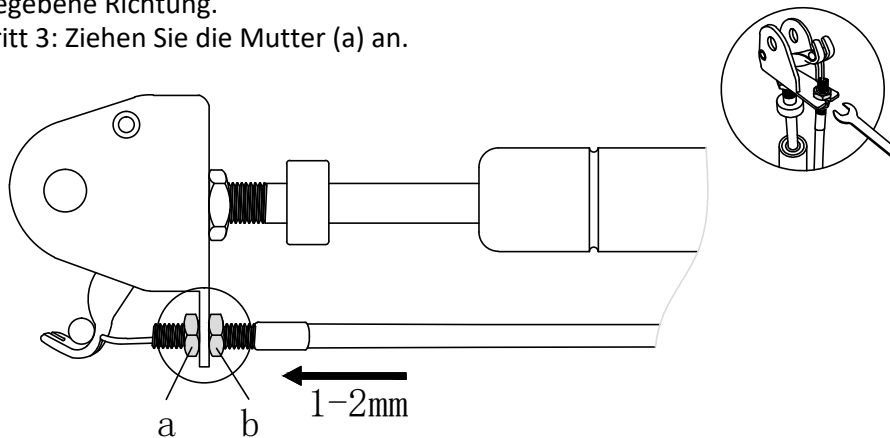

Situation B
Situatie B
Situation B

Backrest can't be adjusted, or barely adjusted
Rugleuning kan niet of nauwelijks versteld worden
Die Rückenlehne ist nicht oder kaum verstellbar

Step 1: Loosen the nut (a) 1-2 mm.
Step 2: Slide the gas spring cable up 1-2mm in the direction indicated by the arrow below.
Step 3: Tighten the nut (b).

Stap 1: Draai de moer (a) 1-2 mm los.
Stap 2: Schuif de kabel van de gasveer 1-2mm op in de richting die de pijl hieronder aangeeft.
Stap 3: Draai de moer (b) aan.

Schritt 1: Lösen Sie die Mutter (a) um 1-2 mm.
Schritt 2: Schieben Sie das Bowdenzug 1-2 mm in die durch den Pfeil unten angegebene Richtung.
Schritt 3: Ziehen Sie die Mutter (b) an.

