

ASSEMBLY PICTURE

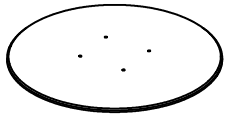

Ax1

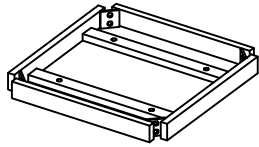

Bx1

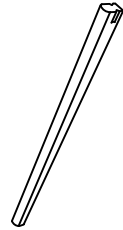

Cx4



Dx4



Ex4



Fx8



Gx8



Hx8

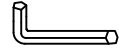

Ix1

①

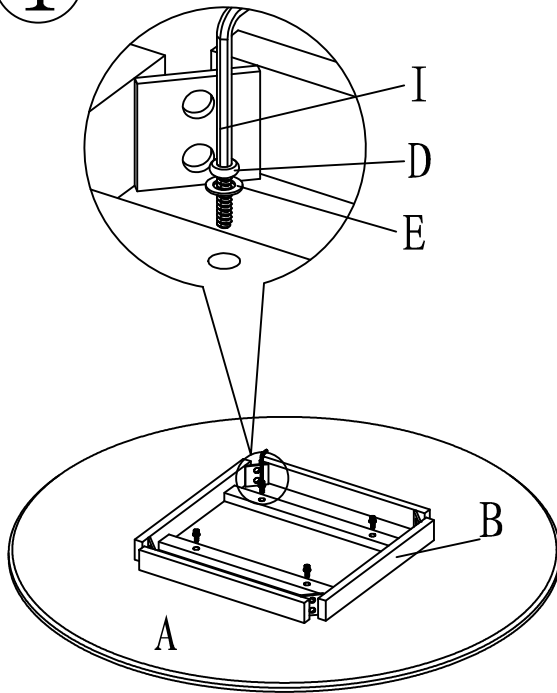

②

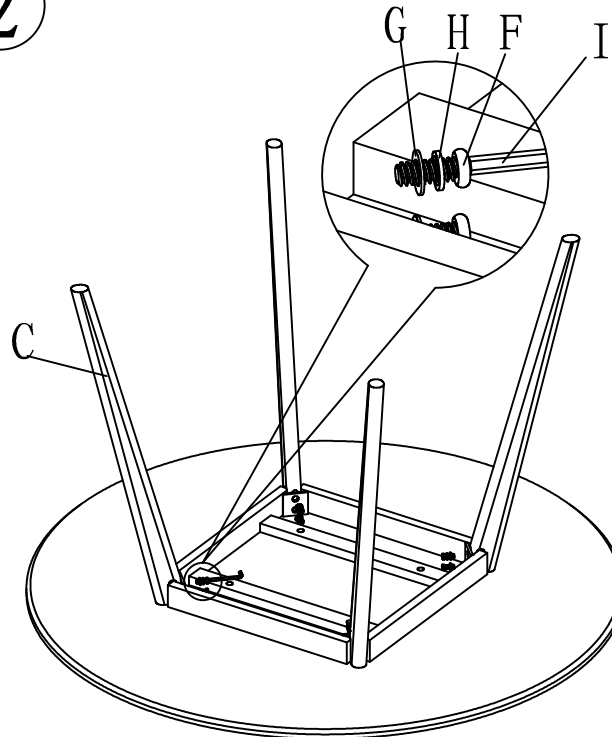

③

