

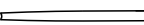





Assemble instruction

GLAC-35717-3831KD (41658)

Part List:

NO.	Picture	Name	Qty
A		Table Top	1
B		Table Leg	4
C		Wrench	1
D		PVC Bolt Cover	8
E		M8X40MM Bolt	8
F		SPRING WASHER	8
G		Steel Washer	8

STEP 1

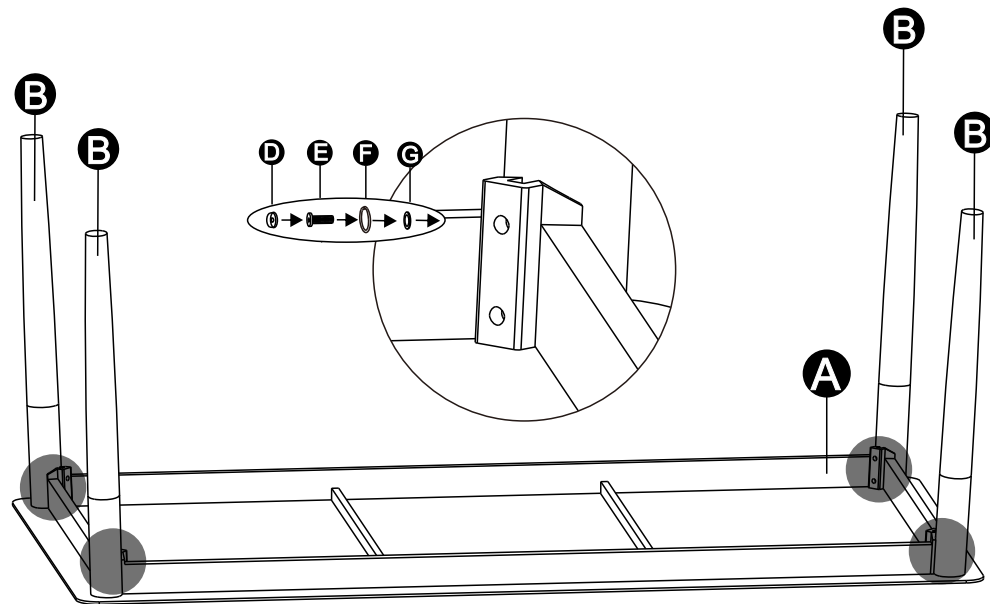

STEP 2

